

Ø 28 - Ø 16 - Ø 13

01 maun / mahogany
لون الماهوجني / цвет красное дерево



02 venge / wenge
اللون بنجي / венге



03 ceviz / walnut
اللون الجوز / орех



04 kiraz / cherry
اللون الكرز / Вишневый розовый



05 meşe / beech
اللون البلوط / дуб



06 akçaağaç / maple
اللون خشب القيقب / Кленовый желтый



07 beyaz / white
أبيض / белый



08 altın yıldız / golden glitter
التذهيب الذهبي / Золотое золочение



09 gümüş yıldız / silver glitter
التذهيب الفضي / Серебряное золочение



Ø 25

07 beyaz / white
أبيض / белый



10 siyah / black
أسود / черный



22 parlak krom / chrome
مشرق / Яркий хром



23 mat krom / chrome
مات / Матовый хром



24 altın kaplama / gold color
الذهب / Золотое покрытие



Ø 20

25 alm. eloksal / andz. alm.
الألمنيوم بالكهرباء / Анодированный алюминий



27 altın yıldız / golden glitter
التذهيب الذهبي / Золотое золочение



53 parlak fime elks. / andz. alm. fime
الألمنيوم / Коррозионно анод



07 beyaz / white
أبيض / белый



11 krem / cream
لون كريم / Цвет сливок



10 siyah / black
أسود / черный



NO	RENK	COLOR	RİGEL	CAPELLA	AQUAMARIN	ONIKS	KUVARS	NATURAL	PLANET	ANTARES	JASPER	VEGA	NORMA	TURMALIN	GARNET	ALCOR	APENA	EPSILON
01	maun	mahogany	●					●	●			●				●		
02	venge	wenge	●				●	●	●			●					●	
03	ceviz	walnut	●				●	●	●			●					●	
04	kiraz	cherry	●					●	●			●					●	
05	meşe	beech	●					●	●			●					●	
06	akçaağaç	maple	●					●	●			●					●	
07	beyaz	white		●		●	●	●	●			●			●	●	●	●
08	altın yıldız	golden glitter					●	●	●			●					●	
09	gümüş yıldız	silver glitter					●	●	●			●					●	
10	siyah	black		●			●	●	●			●					●	
11	krem	cream		●								●						
12	zebrano doğal kap.	zebrano nat. col.																●
13	ceviz doğal kap.	walnut nat. col.																●
14	kayın doğal kap.	beech nat. col.																●
15	altın	gold																●
16	altın eskitme	gold aged																●
17	gümüş	silver																●
18	antik gümüş	antique silver																●
19	gümüş eskitme	silver aged																●
20	abanoz doğal kap.	nat. ebony col.																●
21	kök ceviz kap.	kok walnut col.																●
22	parlak krom	chrome				●	●											
23	mat krom	mat chrome				●	●											
24	altın kaplama	gold color				●	●											
25	altın eloksal	anodized alm.		●								●						
53	parlak fime eloksal	anod. alm. fime		●								●						
27	altın eloksal	anod. alm. gold		●								●						
28	altın varak esk.	gold leaf aged																●
29	gümüş varak esk.	silver leaf aged																●
30	krem eskitme	cream aged																
31	ceviz altın varak	walnut gold leaf																
32	zebrano	zebrano																
33	abanoz	ebony																
34	beyaz - gümüş	white - silver																
35	altın koyu eskitme	gold aged																
36	kırmızı hg	red hg																
37	beyaz hg	white hg																
38	siyah hg	black hg																
39	kahve hg	coffee hg																
40	vizon hg	mink hg																
41	mürdüm hg	damson hg																
42	terra kahve hg	terra coffee hg																
43	abanoz hg	ebony hg																
44	metalik antrasit hg	metallic ant. hg																
45	krem hg	cream hg																
46	leopar	leopard																
47	tekstil	textiles																
48	zebra	zebra																
49	hareli kiraz	cherry accents																
50	beyaz - altın varak	white - gold leaf																
51	bakır eskitme	copper tumbled																
52	ceviz altın eskitme	walnut gold aged																

NOT: Katalogteki renkler diğer renklerle yaklaşık renklerde.
NOTE: Colors in catalog are colors approximate to the product colors.

Примечание: Цвета в каталоге являются приблизительными цветами цветом продукции.
اللون في الكاتالوج هي ألوان تقريبية للون المنتج



RIGEL

RG 10

50 mm

RG 1001 *maun / mahogany / цвет красного дерева / لون الماهوجني*



RG 1002 *wenge / wenge / цвет венге / اللون بنجي*



RG 1006 *akçaağaç / maple / Κλεονοστόν ισημιοτό / اللون خشب القيقب*



RG 2025 *alm. eloksal / anodized alm. / Ανοδιωτισμένη αλουμινίου / الألومنيوم بأكسيد*



RG 10

50 mm

RG 1004 *kiraz / cherry / Вишнявый розовый / اللون الكرز*



RG 1005 *meşe / beech / дуб светлый / اللون البياوط*



RG 2026 *fıme eloksal / anodized alm. / Кованый анод / الألمنيوم*



RG 2027 *altın eloksal / anodized alm. gold / Анодированное золото / الألمنيوم الذهب*



RG 10

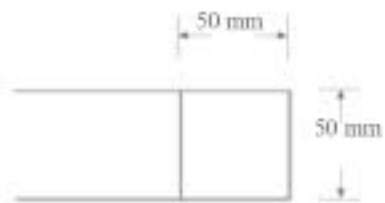

RG 11

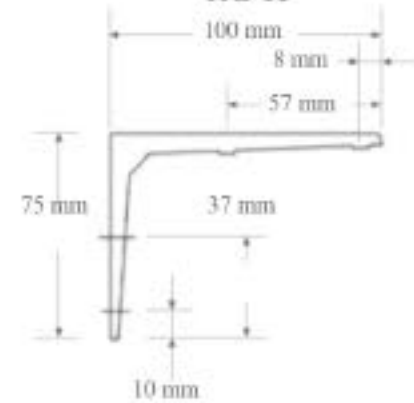

home design
rönesans



CAPELLA



CP 1025

alm. eloksal / andz. alm.
الالومنيوم باكسيديزاسمانتس



CP 1053

parlak fümre elks. / andz. alm. fümre
الالومنيوم كونيكتي انود



CP 1027

altın yıldız / golden glitter
الالومنيوم الذهب/الالومنيوم



CP 1007

beyaz / white
بيج / ابيض



CP 1011

krem / cream
لون كريم/كريمه



CP 1010

siyah / black
سود / ايسود



CP 2025

alm. eloksal / andz. alm.
الالومنيوم باكسيديزاسمانتس



CP 2053

parlak fümre elks. / andz. alm. fümre
الالومنيوم كونيكتي انود



CP 2027

altın yıldız / golden glitter
الالومنيوم الذهب/الالومنيوم



CP 2007

beyaz / white
بيج / ابيض



CP 2011

krem / cream
لون كريم/كريمه



CP 2010

siyah / black
سود / ايسود



CP 3025

alm. eloksal / andz. alm.
الالومنيوم باكسيديزاسمانتس



CP 3053

parlak fümre elks. / andz. alm. fümre
الالومنيوم كونيكتي انود



CP 3027

altın yıldız / golden glitter
الالومنيوم الذهب/الالومنيوم



CP 3007

beyaz / white
بيج / ابيض



CP 3011

krem / cream
لون كريم/كريمه



CP 3010

siyah / black
سود / ايسود



CP 4025

alm. eloksal / andz. alm.
الالومنيوم باكسيديزاسمانتس



CP 4053

parlak fümre elks. / andz. alm. fümre
الالومنيوم كونيكتي انود



CP 4027

altın yıldız / golden glitter
الالومنيوم الذهب/الالومنيوم



CP 4007

beyaz / white
بيج / ابيض



CP 4011

krem / cream
لون كريم/كريمه



CP 4010

siyah / black
سود / ايسود





AKUAMARİN

AK 10

Ø 25

AK 1022 parlak krom / chrome / Яркий хром / مشرق كروم



AK 1023 mat krom / chrome / Матовый хром / مات كروم



AK 1024 altın kaplama / gold color / Золотое покрытие / الذهب



AK 20

Ø 25

AK 2022 parlak krom / chrome / Яркий хром / مشرقى كروم



AK 2023 mat krom / chrome / Матовый хром / ماتى كروم



AK 2024 altın kaplama / gold color / Золотое покрытие / الذهب



AK 30

Ø 25

AK 3022 parlak krom / chrome / Яркий хром / مشرقى كروم



AK 3023 mat krom / chrome / Матовый хром / ماتى كروم



AK 3024 altın kaplama / gold color / Золотое покрытие / الذهب



AK 40

Ø 25

AK 4007 parlak krom beyaz / chrome white / Яркий хром белый / مشرق كروم



AK 5010 parlak krom siyah / chrome black / Яркий хром черный / مشرق كروم



AK 5107 parlak krom beyaz / chrome white / Яркий хром белый / مشرق كروم



AK 5124
altın kaplama
gold color
Золотое покрытие
الذهب

Parlak Krom / Chrome

Яркий хром / مشرق كروم

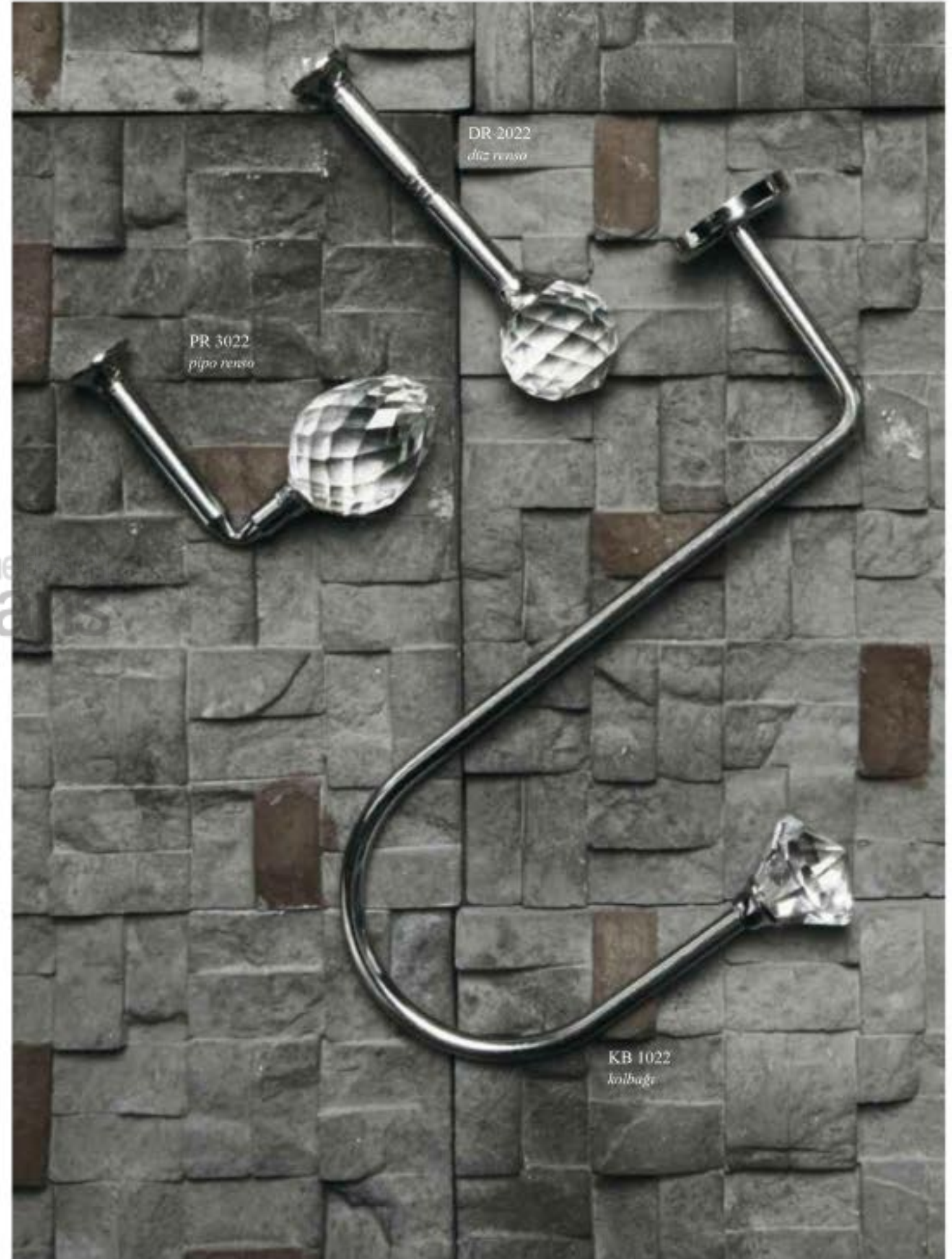

DR 2022
düz renso

PR 3022
pipa renso

KB 1022
kolbağı



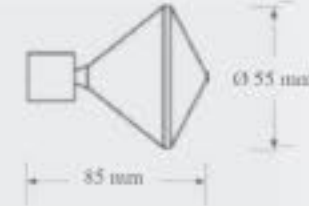

AK 10

başlık
finial
окончательный
نهائي

AK 20

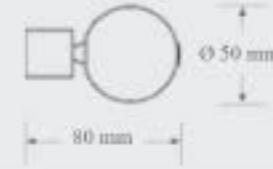
başlık
finial
окончательный
نهائي

AK 30

başlık
finial
окончательный
نهائي

AK 40

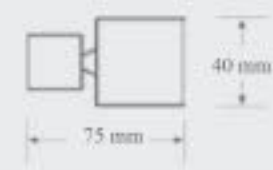
başlık
finial
окончательный
نهائي

AK 50 - 51

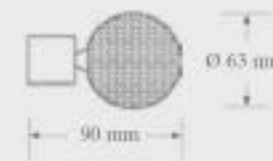
başlık
finial
окончательный
نهائي

Boru

Tube

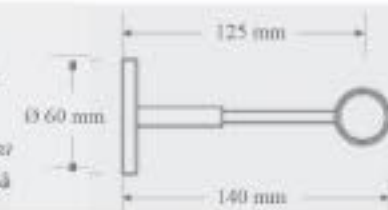

AKA 01

rustik ayağı
bracket
резная полка
قدم ريفي عادي

AKA 02

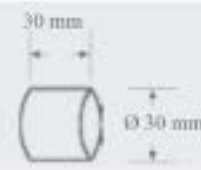
yan duvar aprt.
side wall bracket appar.
Боковая стена
جذب جدار اللدم

AKA 03

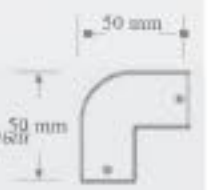
köşe dönüştür.
finial
аппарат/приспособление угловой поворота
قطعة زاوية

AKA 04

metalik halka
metallic ring
Металлическое кольцо
حلقة معدنية

KB

kolbağı
ادصال الستار

PR

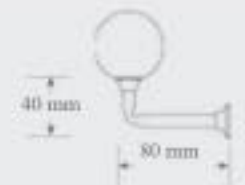
pipo renso
Pipo Renso
ادصال الستار

DR

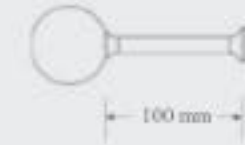
düz renso
прямой Renso
ادصال الستار

Klips

Clips

Клипы

مخربص



Rustik Rayı

Rail

резная направляющая

سكة حديدية



Ray Keleşesi

Халут, держатель направляющей

ادصال السكة الحديدية





ONIKS

OK 10

Ø 25



OK 1012
zebrano ağacı / zebrano wood
زیدرانو الطبیعی / Природный зебрано

OK 1007
beyaz / white
بەنیا / أبيض



OK 1013
ceviz ağacı / walnut wood
الچوز الطبیعی / Естественный орех

OK 1010
siyah / black
سود / чёрный



OK 1014
kayın ağacı / beach wood
خشب الزان الطبیعی / Природный бук

AOK 1012
ahşap ayak zebrano
wood bracket zebrano
زیدرانو الطبیعی / Деревянная ножка зебрано





OK 2012
zebrano ağacı / zebrano wood
زيبرانو الطبيعي / природный зебрано



OK 2013
ceviz ağacı / walnut wood
الجوز الطبيعي / природный орех



OK 2014
kayın ağacı / beech wood
خشب الزان الطبيعي / природный бук



OK 2007
beyaz / white
أبيض / ض



OK 2010
siyah / black
أسود / س



AOK 2010
ahşap ayak siyah
wood bracket black
Деревянная ножка черная
زيبرانو الطبيعي



OK 3012
zebrano ağacı / zebrano wood
زيبرانو الطبيعي / природный зебрано



OK 3013
ceviz ağacı / walnut wood
الجوز الطبيعي / природный орех



OK 3014
kayın ağacı / beech wood
خشب الزان الطبيعي / природный бук



OK 3007
beyaz / white
أبيض / ض



OK 3010
siyah / black
أسود / س



AOK 3014
ahşap ayak kayın ağacı
beech wood bracket
Деревянная ножка Природный бук
زيبرانو الطبيعي





OK 4012
zebrano ağacı / zebrano wood
زیرانو لطیبعی / Природный зебрано



OK 4013
ceviz ağacı / walnut wood
الجوز الطیبعی / Естественный орех



OK 4014
kayın ağacı / beach wood
خشب الزان الطیبعی / Природный бук



OK 4007
beyaz / white
أبیض / белый



OK 4010
siyah / black
سود / черный



AOK 4013
ahşap ayak ceviz ağacı
walnut wood bracket
Деревянная ножка
زیرانو لطیبعی / Естественный



OK 5012
zebrano ağacı / zebrano wood
زیرانو لطیبعی / Природный зебрано



OK 5013
ceviz ağacı / walnut wood
الجوز الطیبعی / Естественный орех



OK 5014
kayın ağacı / beach wood
خشب الزان الطیبعی / Природный бук



OK 5007
beyaz / white
أبیض / белый



OK 5010
siyah / black
سود / черный



AOK 5007
ahşap ayak beyaz
white wood bracket
Деревянная ножка белая
زیرانو لطیبعی / Естественный



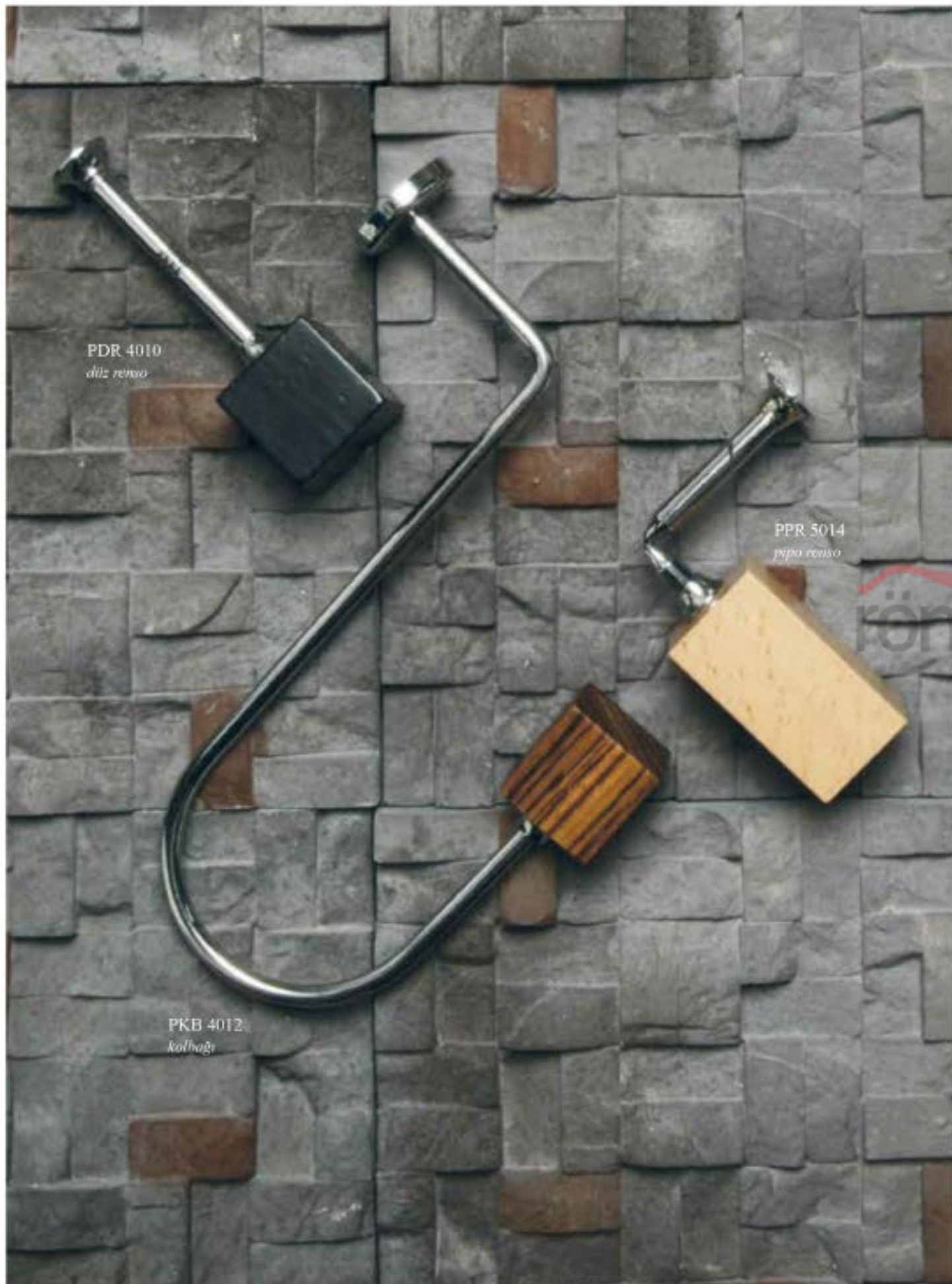



OK 10
bağlık
final
окончательный
نهائي

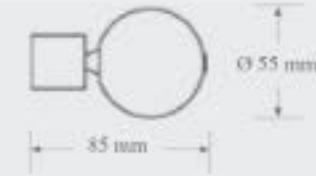

OK 20
bağlık
final
окончательный
نهائي

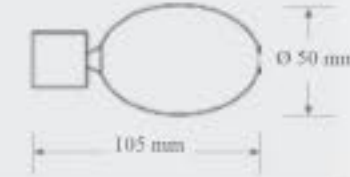

AK 30
bağlık
final
окончательный
نهائي

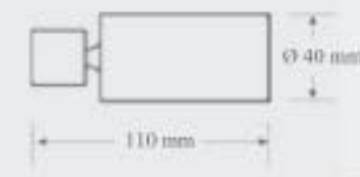

OK 40
bağlık
final
окончательный
نهائي

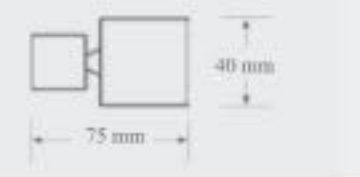

OK 50
bağlık
final
окончательный
نهائي

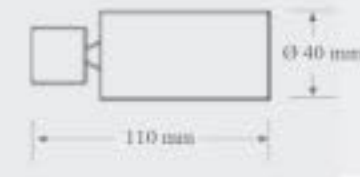

Boru
Tube



OKA 01
rustik ayağı
bracket
рестная ножка
قدم بقوي عادي

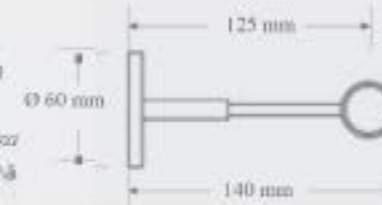

OKA 02
rustik ayağı
bracket
рестная ножка
قدم بقوي عادي

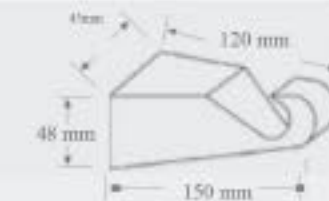

OKA 03
yan duvar aprt.
side wall bracket appar.
Боковая стенка
جاذب جدار القدم

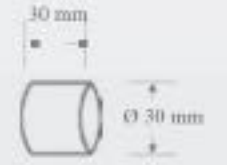

OKA 04
köşe dönlü aprt.
final
aygıt/ приспособление
قطعة زاوية

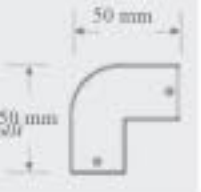

OKA 05
metalik halka
metallic ring
Металлическое кольцо
حلقة معدنية



KB
kolbağı
اتصال الستار



PR
pipo renso
Pipo Renso
اتصال الستار

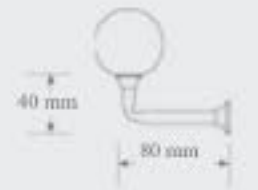

DR
düz renso
прямой Renso
اتصال الستار

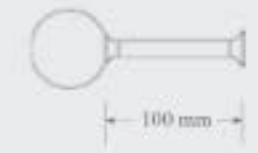

Rustik Rayı
Rail
рельса направляющая
سكة حديدية



Ray Kelepçesi
Хомут, держатель направляющей
ذراع مساعد السكة الحديدية





SIRIUS

SR 10 - 20 - 30

Ø 25

SR 1022 *parlak krom / chrome / Яркый хром / مشرق*
175 mm x 100 mm



SR 2022 *parlak krom / chrome / Яркый хром / مشرق*
130 mm x 110 mm



SR 3022 *parlak krom / chrome / Яркый хром / مشرق*
115 mm x 70 mm





KUVARAS



KS 1002
venge / wenge
الأون ينجي

KS 1008
altın yaldız / golden glitter
التذهيب الذهب



KS 1003
ceviz / walnut
الأون الجوز

KS 1009
gümüş yaldız / silver glitter
التذهيب الفضة



KS 1007
beyaz / white
أبيض

KS 1010
siyah / black
أسود





KS 2002
venge / wenge
للون يدجي / نهنه



KS 2003
ceviz / walnut
للون الجوز / اهنه



KS 2007
beyaz / white
ابن / اهنه



KS 2008
altın yıldız / golden glitter
للنهنه النهنه النهنه / النهنه



KS 2009
gümüş yıldız / silver glitter
للنهنه النهنه النهنه / النهنه



KS 2010
siyah / black
أسود / اهنه



KS 3002
venge / wenge
للون يدجي / نهنه



KS 3003
ceviz / walnut
للون الجوز / اهنه



KS 3007
beyaz / white
ابن / اهنه



KS 3008
altın yıldız / golden glitter
للنهنه النهنه النهنه / النهنه



KS 3009
gümüş yıldız / silver glitter
للنهنه النهنه النهنه / النهنه



KS 3010
siyah / black
أسود / اهنه



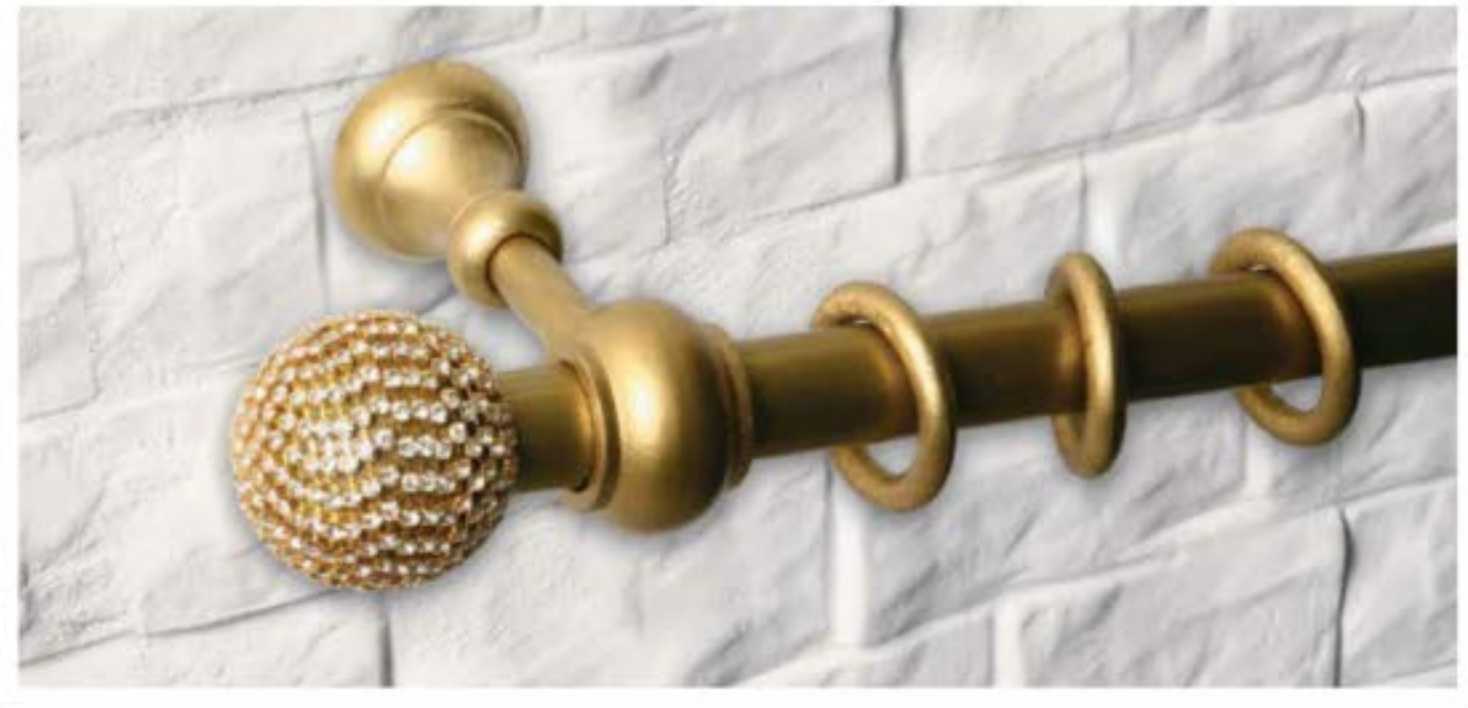

KS 4002
venge / wenge
للون ينجي / wenge



KS 4008
altın yaldız / golden glitter
التذهيب الذهب ينجي / altın yaldız



KS 5002
venge / wenge
للون ينجي / wenge



KS 5008
altın yaldız / golden glitter
التذهيب الذهب ينجي / altın yaldız



KS 4003
ceviz / walnut
للون الجوز / ceviz



KS 4009
gümüş yaldız / silver glitter
التذهيب الفضي ينجي / gümüş yaldız



KS 5003
ceviz / walnut
للون الجوز / ceviz



KS 5009
gümüş yaldız / silver glitter
التذهيب الفضي ينجي / gümüş yaldız



KS 4007
beyaz / white
أبيض / beyaz



KS 4010
siyah / black
أسود / siyah



KS 5007
beyaz / white
أبيض / beyaz



KS 5010
siyah / black
أسود / siyah





KS 6002
venge / wenge
للون يدجي، nence



KS 6008
altın yıldız / golden glitter
التذهب الذهب النجومية



KS 6003
ceviz / walnut
للون الجوز، opex



KS 6009
gümüş yıldız / silver glitter
التذهب الفضي النجومية



KS 6007
beyaz / white
أبيض، beyaz



KS 6010
siyah / black
أسود، siyah



KSR 1010
siyah / black
أسود، siyah



KSR 4002
venge / wenge
للون يدجي، nence



KSR 2007
beyaz / white
أبيض، beyaz



KSR 5009
gümüş yıldız / silver glitter
التذهب الفضي النجومية



KSR 3008
altın yıldız / golden glitter
التذهب الذهب النجومية



KSR 6003
ceviz / walnut
للون الجوز، opex



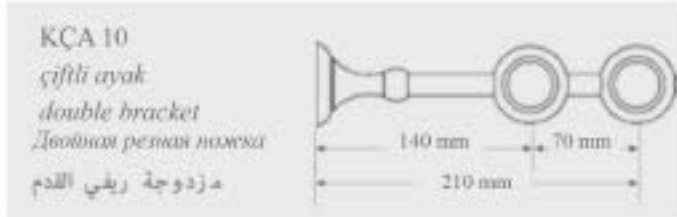
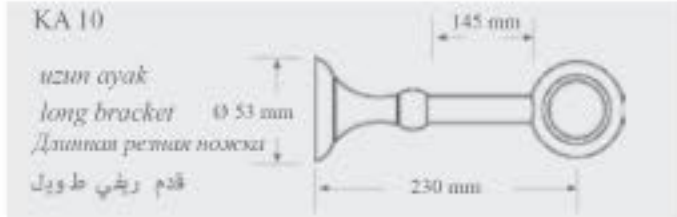
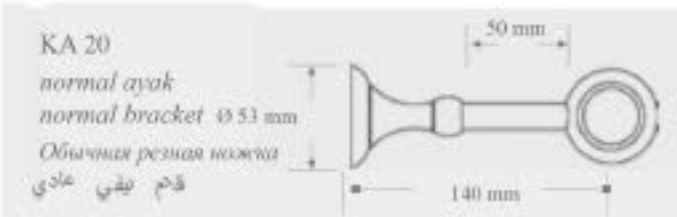
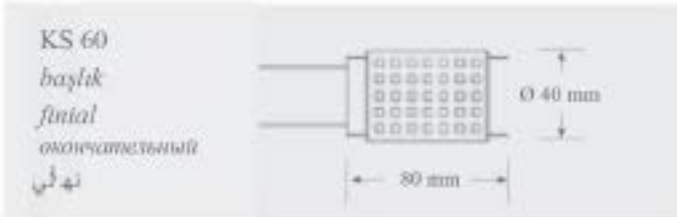
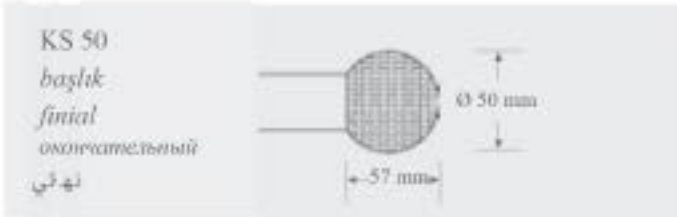
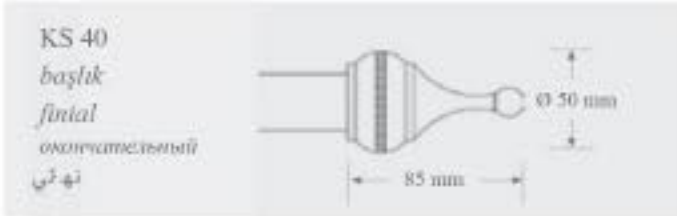
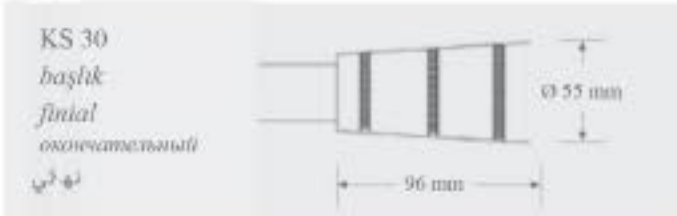
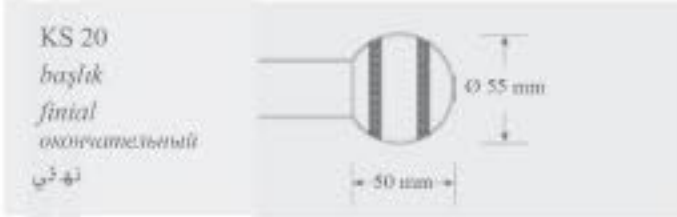
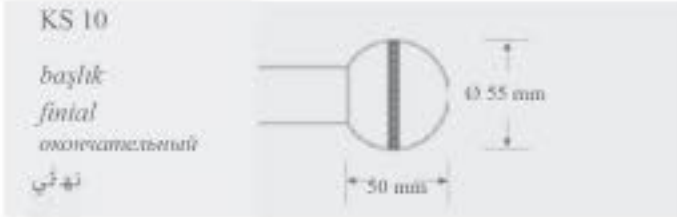

NATURAL



NT 1001
maun / mahogany / красное дерево / لون الماهوجني



NT 1002
venge / wenge / senze / اللون ينجي



NT 1003
ceviz / walnut / opex / اللون الاجوز



NT 1004
kiraz / cherry / Вишневый позолоты / اللون كرز



NT 1005
meşe / beech / dyö üsem / اللون البياوط



NT 1006
akcağaç / maple / Кленовый / اللون خشب القيقب



NT 1007
beyaz / white / beynsi / أبيض



NT 1008
altın yal. / golden glit. / Золотое позолоты / التذهيب الذهب



NT 1009
gümüş yal. / silver glit. / Серебряное позолоты / التذهيب الفضي



NT 1010
siyah / black / qepnisi / أسود



NT 2001
maun / mahogany / красное дерево / لون الماهوجني



NT 2002
venge / wenge / senze / اللون ينجي



NT 2003
ceviz / walnut / opex / اللون الاجوز



NT 2004
kiraz / cherry / Вишневый / اللون كرز



NT 2005
meşe / beech / dyö üsem / اللون البياوط



NT 2006
akcağaç / maple / Кленовый / اللون خشب القيقب



NT 2007
beyaz / white / beynsi / أبيض



NT 2008
altın yal. / golden glit. / Золотое позолоты / التذهيب الذهب



NT 2009
gümüş yal. / silver glit. / Серебряное позолоты / التذهيب الفضي



NT 2010
siyah / black / qepnisi / أسود





NT 3001
mah / mahogany / красное дерево / لون الماهوجني



NT 2002
venge / wenge / senze / اللون ينجي



NT 3003
ceviz / walnut / apex / اللون الجوز



NT 3004
kiraz / cherry / Вишнялык розовлык / اللون الكرز



NT 3005
meşe / beech / dyğ qsem / اللون البلوط



NT 3006
akcağaç / maple / Кленлык qsemлык / اللون خشب القيقب



NT 3007
beyaz / white / beyns / أبيض



NT 3008
altın yal. / golden glit. / Золоток sarıqemлык / التذهيب الذهب



NT 3009
gümüş yal. / silver glit. / Серебрялык sarıqemлык / التذهيب الفضة



NT 3010
siyah / black / qepnıslı / أسود



FA 10
uzun ayak
long bracket

FCA 10
çiftli ayak
double bracket

FA 20
normal ayak
normal bracket

FRA 30
rengö
hand backs

FYA 10
yan divar aprt.
side wall bracket upper

FKA 10
köşe eksantrik aprt.
corner eccentric aprt.

NT 10
başlık
finial
окончателный
نهائي

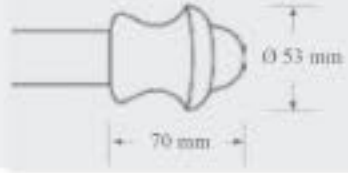

FYA 20
yan duvar aprt.
side wall bracket appar.
Боковая стенка
جاذب جدار القدم

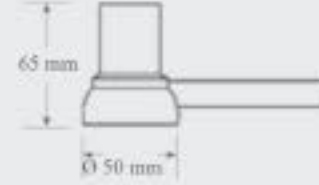

NT 20
başlık
finial
окончателный
نهائي

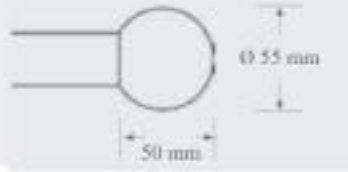

Ahşap Halka
Wood Ring
Деревянное кольцо
خاتم خشبي

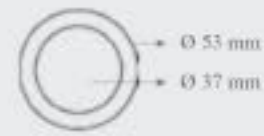

NT 30
başlık
finial
окончателный
نهائي

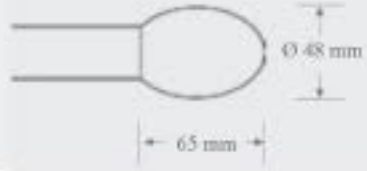

Plastik Halka
Plastic Ring
Пластиковое кольцо
حلقة بلاستيكية



Boru
Tube



FKA 10
köşe eksenrik aprt.
corner eccentric aprt.
аппарат/приспособление угловой
эксцентрический
قطعة زاوية

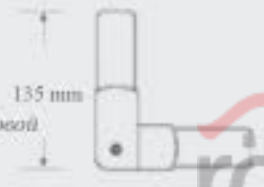

FA 20
normal ayak
normal bracket Ø 53 mm
Обычная резная ножка
قدم ريفي عادي

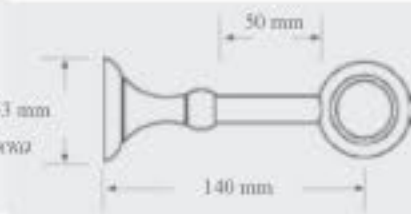

FRA 30
renso
hold backs
прямые
اذصال الستار

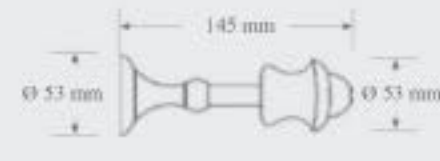

FA 10
uzun ayak
long bracket Ø 53 mm
Длинная резная ножка
قدم ريفي طويل

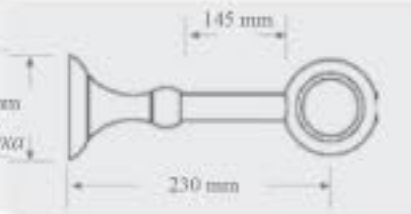

Plastik Klips
Plastic Clips
пластиковые клипсы
مخمس بلاستيكية



FÇA 10
çiftli ayak
double bracket
Двойная резная ножка
مزدوجة ريفي القدم

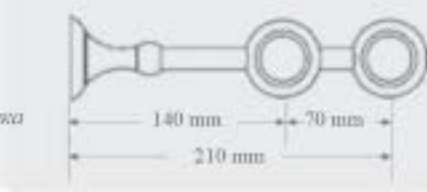

Rustik Rayı
Rail
резная направляющая
سكة حديدية



FYA 10
yan duvar aprt.
side wall bracket appar.
Боковая стенка
جاذب جدار القدم

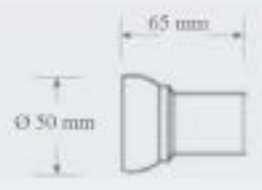

Ray Kelepçesi
Ханут, держатель направляющей
ذ صاعد السكة الحديدية





PL 1001
maun / mahogany
لون الماهوجني / цвет красное дерево



PL 1002
wenge / wenge
اللون يدجي / wenge



PL 1003
ceviz / walnut
اللون الجوز / орех



PL 1004
kiraz / cherry
اللون الكرز / Вишневый

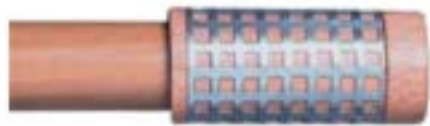

PL 1005
meşe / beech
اللون البلوط / дуб



PL 1006
akçaağaç / maple
اللون خشب القيقب / Кленовый



PL 1007
beyaz / white
أبيض / белый



PL 1008
altın yıldız / golden glitter
التنظير الذهب / Золотое



PL 1009
gümüş yıldız / silver glitter
التنظير الفضي / Серебряное



PL 1010
siyah / black
أسود / черный



PL 2001
maun / mahogany
لون الماهوجني / цвет красное дерево



PL 2002
wenge / wenge
اللون يدجي / wenge



PL 2003
ceviz / walnut
اللون الجوز / орех



PL 2004
kiraz / cherry
اللون الكرز / Вишневый



PL 2005
meşe / beech
اللون البلوط / дуб



PL 2006
akçaağaç / maple
اللون خشب القيقب / Кленовый



PL 2007
beyaz / white
أبيض / белый



PL 2008
altın yıldız / golden glitter
التنظير الذهب / Золотое



PL 2009
gümüş yıldız / silver glitter
التنظير الفضي / Серебряное



PL 2010
siyah / black
أسود / черный





PL 3001
mahon / mahogany
اللون الماهوجني / цвет красное дерево



PL 3002
wenge / wenge
اللون ينجي / wenge



PL 3003
ceviz / walnut
اللون الجوز / орех



PL 3004
kiraz / cherry
اللون الكرز / Вишневый



PL 3005
meşe / beech
اللون البتوط / дуб



PL 3006
akçaağaç / maple
اللون خشب القيقب / Кленовый



PL 3007
beyaz / white
اللون ابيض / белый



PL 3008
altın yıldız / golden glitter
التنوير الذهب / Золотое сияние



PL 3009
gümüş yıldız / silver glitter
التنوير الفضي / Серебряное сияние



PL 3010
siyah / black
اللون اسود / черный



FKA 10
köşe eksantrik aprt.
corner eccentric aprt.

Boru
Tube

Plastik Klips
Plastic Clips

Ray Kelepçesi

FYA 10
yan duvar aprt.
side wall bracket appar.

Rustik Ray
Rail

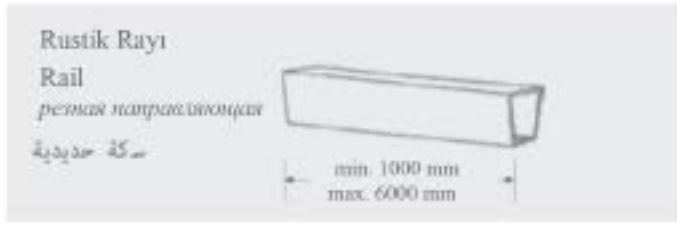
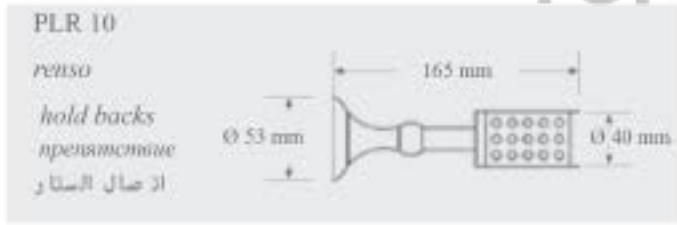
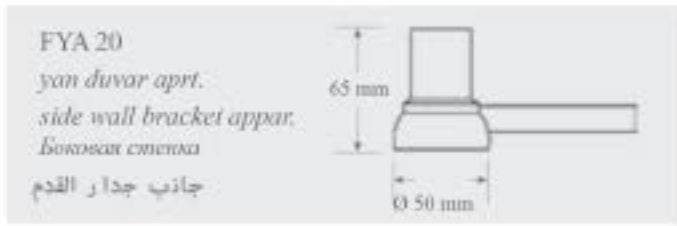
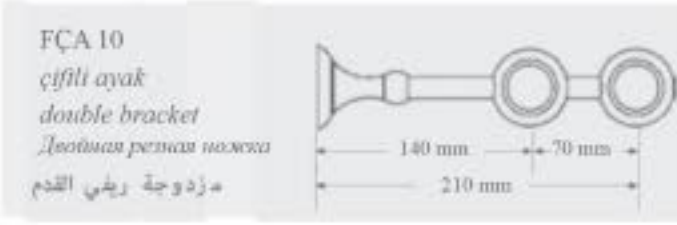
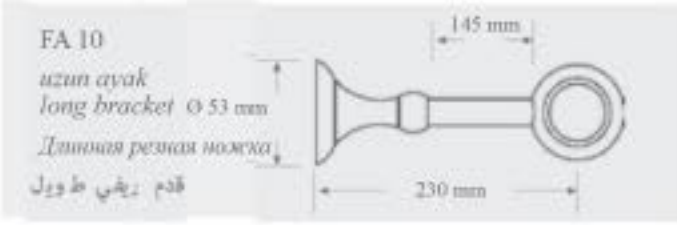
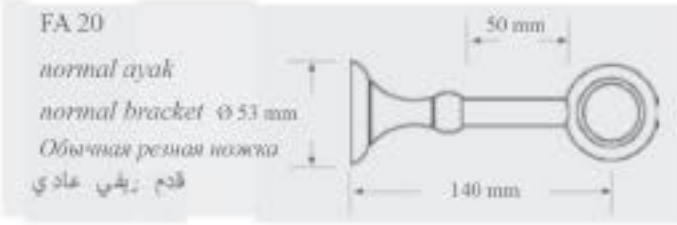
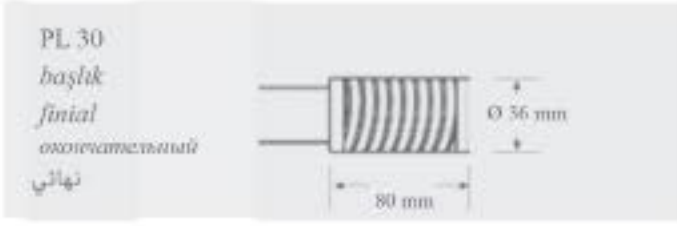
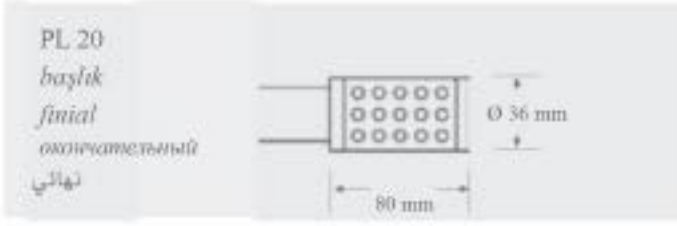
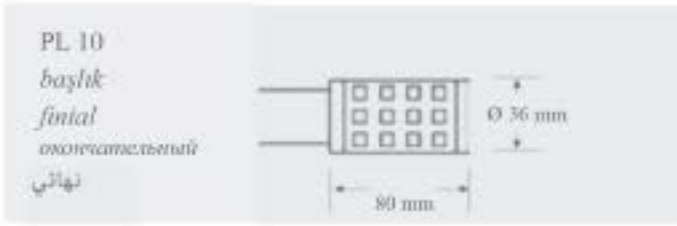

AR 0115 altın / gold / xaxomo / الذهب



AR 0219 gümüş eskitme / silver aged / Cepçapanoe crapenie / لؤلؤ فضي القديم

AR 1219



home design
rönesans

AR 0134 beyaz - gümüş / white - silver / Белый - серебряный / لؤلؤ فضي

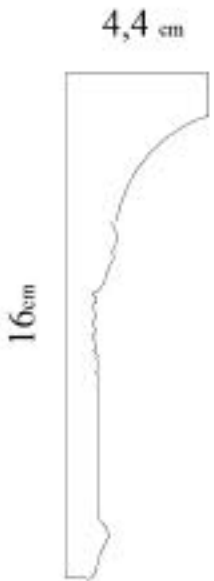

AR 0216 altın eskitme / gold aged / состаренное золото / لؤلؤ القديم

AR 1216

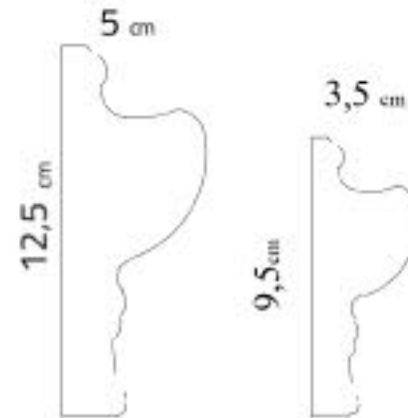

AR 02

AR 12



AR 0303 *ceviz / walnut / opex / اللون الجوز*



AR 0816 *altın eskitme / gold aged / состаренное золото / الذهب القديم*



AR 0305 *meşe / beech / dyû qem / اللون البلوط*



2,5 cm



12,5 cm

AR 0306 *akçaağaç / maple / Кленовий цвемлю / اللون عشب القيقب*



AR 0307 *beyaz / white / белый / أبيض*



5,3 cm

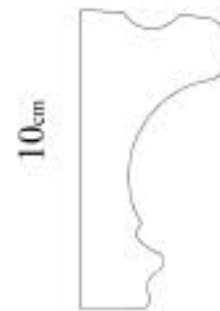

10 cm

AR 0819 *gümüş eskitme / silver aged / Серебряное старение / الفضة القديم*



AR 05

AR 0535 altın koyu eskitme / gold aged / Золотая Темная Антураж / الذهب القديم



AR 09

AR 0917 gümüş / silver / серебро / الفضي



AR 0552 ceviz altın eskitme / walnut gold aged / Ореховое золото / الجوز الذهب القديم

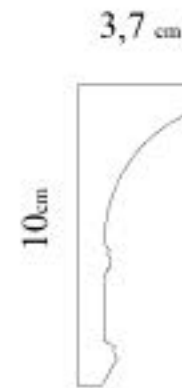

AR 0915 altın / gold / золото / الذهب



AR 1015 altın / gold / золото / الذهب



AR 1017 gümüş / silver / серебро / الفضي



AR 1007 beyaz / white / белый / أبيض



AR 1316 altın eskitme / gold aged / состаренное золото / الذهب القديم



AR 1319 gümüş eskitme / silver aged / Серебряное старение / الفضي القديم



TAC

TC 1116 *altın eskitme / gold aged / состаренное золото / الذهب القديم*
65 cm x 22 cm



TC 1216 *altın eskitme / gold aged / состаренное золото / الذهب القديم*
65 cm x 16 cm



TC 1316 *altın eskitme / gold aged / состаренное золото / الذهب القديم*
64 cm x 14 cm



TC 1416 *altın eskitme / gold aged / состаренное золото / الذهب القديم*
54 cm x 12 cm



JP 1040 *vizon hg / vision hg / Яркий Визон / كريم فاناخ مشرق*

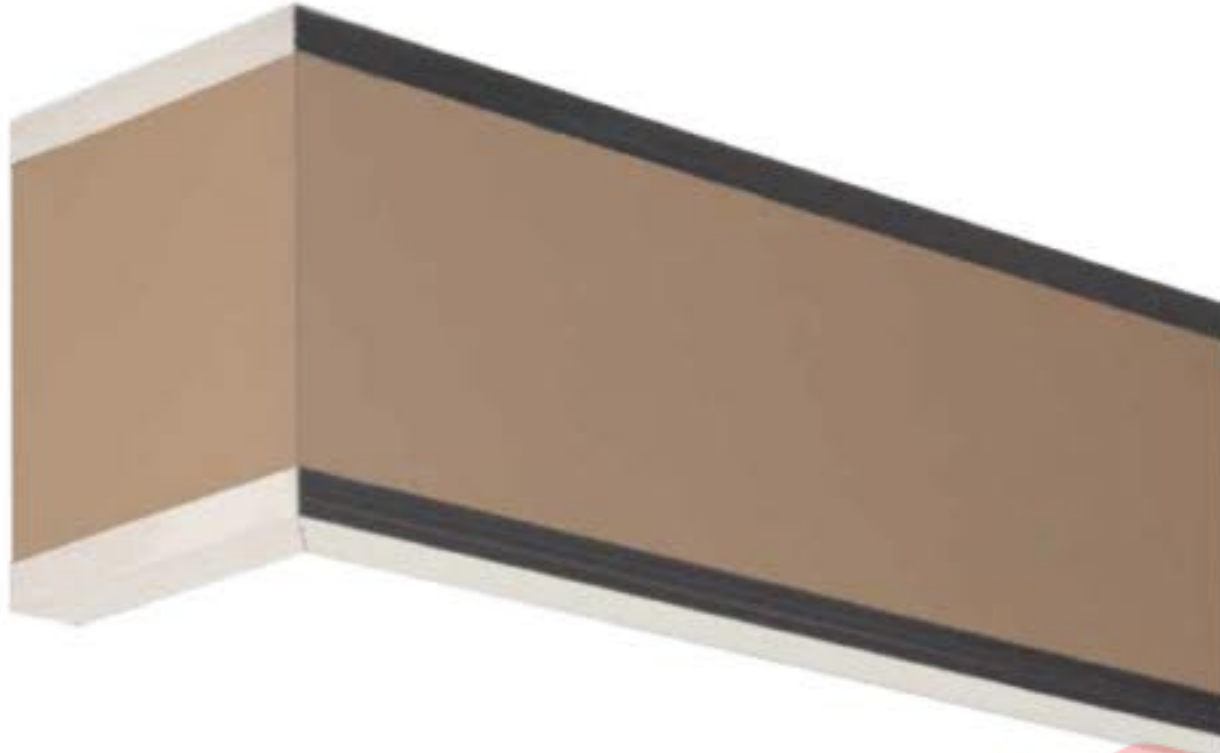

JP 1041 *mürdüm hg / damson hg / Яркий вишня / مزرديم مشرق*

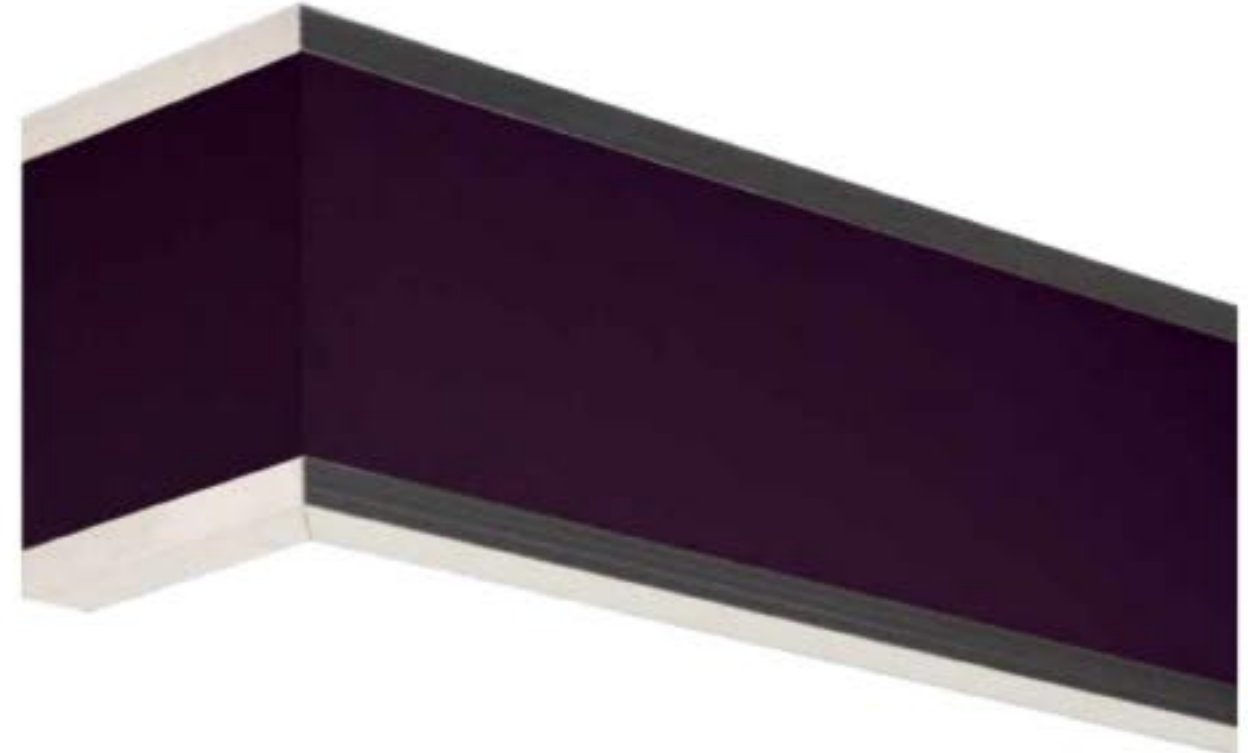

JP 1036 *kırmızı hg / red hg / Яркий красный / أحمر مشرق*



JP 1037 *bej hg / white hg / Яркий белый / أبيض مشرق*



JP 1042 *siyah kahve hg / tetra coffee hg / Яркий Terra Кофе / القهوة المشرق*



JP 1043 *ahşap hg / ebony hg / Яркое черное дерево / خشب الأبنوس الطبيعي مشرق*



JP 1038 *siyah hg / black hg / Яркий черный / أسود مشرق*



JP 1039 *kahve hg / coffee hg / Яркий кофе / القهوة المشرق*



JP 1044 *metalik antrasit hg / metallic anthracite hg / Яркий металлический антрацит / زمادي معدني مشرق*



JP 1045 *krem hg / cream hg / Яркий крем / كريم مشرق*



home design
rönesans



VEGA

home design
rönesans

VG 10

VG 1046 *leopard / leopard / леопард /* قهوه



VG 1047 *tekstil / textiles / текстиль /* المنسوجات



VG 1048 *zebra / zebra / зебра /* دمار الوحش





VG 10

VG 1025

alüminyum eloksal / anodised aluminium
الألومنيوم بأكسيد الألمنيوم



VG 1026

fıne eloksal / anodized alm.
كرومات الألمنيوم



VG 1027

altın eloksal / anodized alm. gold
الألمنيوم الذهب



VG 1032

zebrano / zebrano
زبرانو



VG 1049

hardi kiraz / cherry accents
هاردلي الكرز

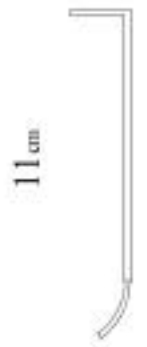

NR 10

NR 1003
ceviz / walnut / opex / اللون الجوز



NR 1004
kiraz / cherry / Виноградный розовый / اللون الكرز



NR 1005
meşe / beach / dyđ tşem / اللون البوط



NR 1006
akçağaç / maple / Кленовый желтый / اللون خشب القيقب



NR 1009
gümüş yıldız / silver glitter / Серебряное золочение / التذهيب الفضي



NR 1010
siyah / black / черный / أسود



NR 1011
krem / cream / Цвет крема / لون كريم



NR 1033
abonuz / ebony / черное дерево / خشب الأبنوس الطبيعي





TURMALIN

TR

TR 1047

düz kumaş kaplama / straight cover upholstery
Илоское покрытие из ткани / تغطى النسيج المسطح



TR 2047

kapitone kumaş kaplama / quilted upholstery
كابتوننا تغطى النسيج / Стежаниое покрытие из ткани

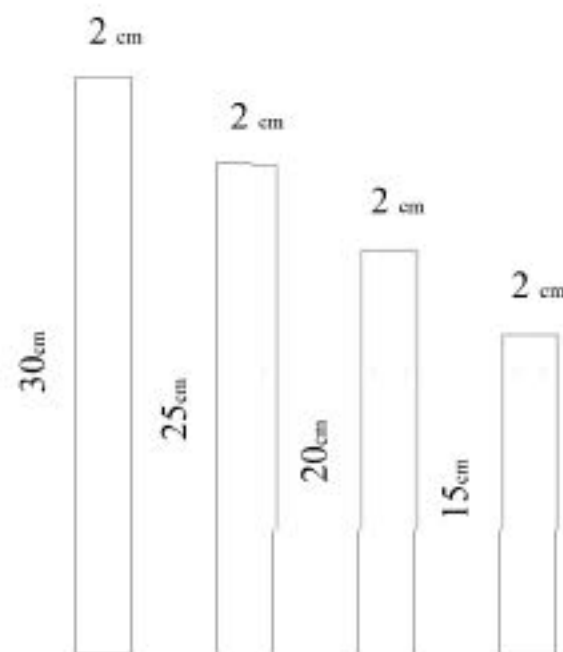



GN 10

GN 1013 *ceviz / walnut / opex / اللون الجوز*



GN 1050 *beyaz-altın varak / white - gold leaf / Белый - Золотая фольга / الذهب اللدیم / أبيض*



GN 1028 *altın varak eskime / gold leaf aged / Старение золотой фольги / الذهب اللدیم*





ALCOR

AC 10

AC 1001
maun / mahogany
لون الماهوجني / цвет красное дерево



AC 1012
zebrano / zebirano
زابرانو / Зебрано



AC 1020
abonos / ebony
خشب الأبنوس الطبيعي / черное дерево



AC 1013
ceviz / walnut
اللون الجوز / орех



AC 1014
kayın / beech
خشب الزان الطبيعي / Природный бук





AP 10

Xx mm

AP 1002
venge / wenge / wenge / اللون يتجي



AP 1003
ceviz / walnut / opex / اللون الجوز



AP 1004
kiraz / cherry / Висневий розовий / اللون الكرز



AP 1005
meşe / beech / дуб ясень / اللون البلوط



AP 1006
akçaağaç / maple / Кленовий світлий / اللون خشب القيقب



AP 1007
beyaz / white / беілий / أبيض



AP 1008
altın yal. / golden glit. / Золотое озарення / التذهيب الذهبي



AP 1009
gümüş yal. / silver glit. / Сребряне озарення / التذهيب الفضي



AP 1010
siyah / black / чорний / أسود

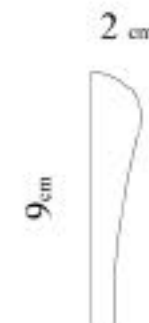

ES 10

ES 1013
ceviz / walnut
اللون الجوز / opex



ES 1007
beyaz / white
أبيض / أبيض

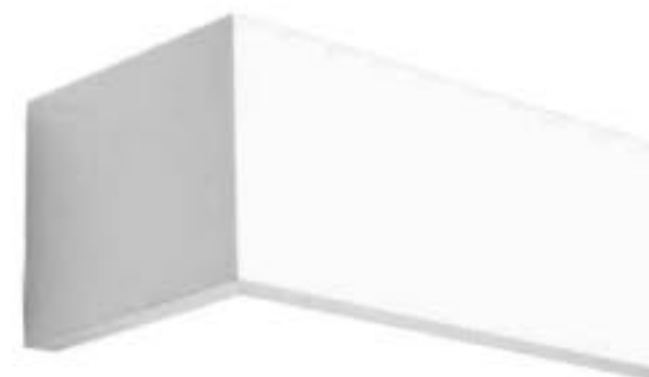

ES 1012
zebrano / zebbrano
زبرانو / Зебрано



ES 1014
kayın / beech
خشب الزان الطبيعي / Природный брус



ES 1020
abanoz / ebony
خشب الأبنوس الطبيعي / черное дерево



ES 1021
kök ceviz / kök walnut
خشب الأبنوس الطبيعي / Коричневое ореховое



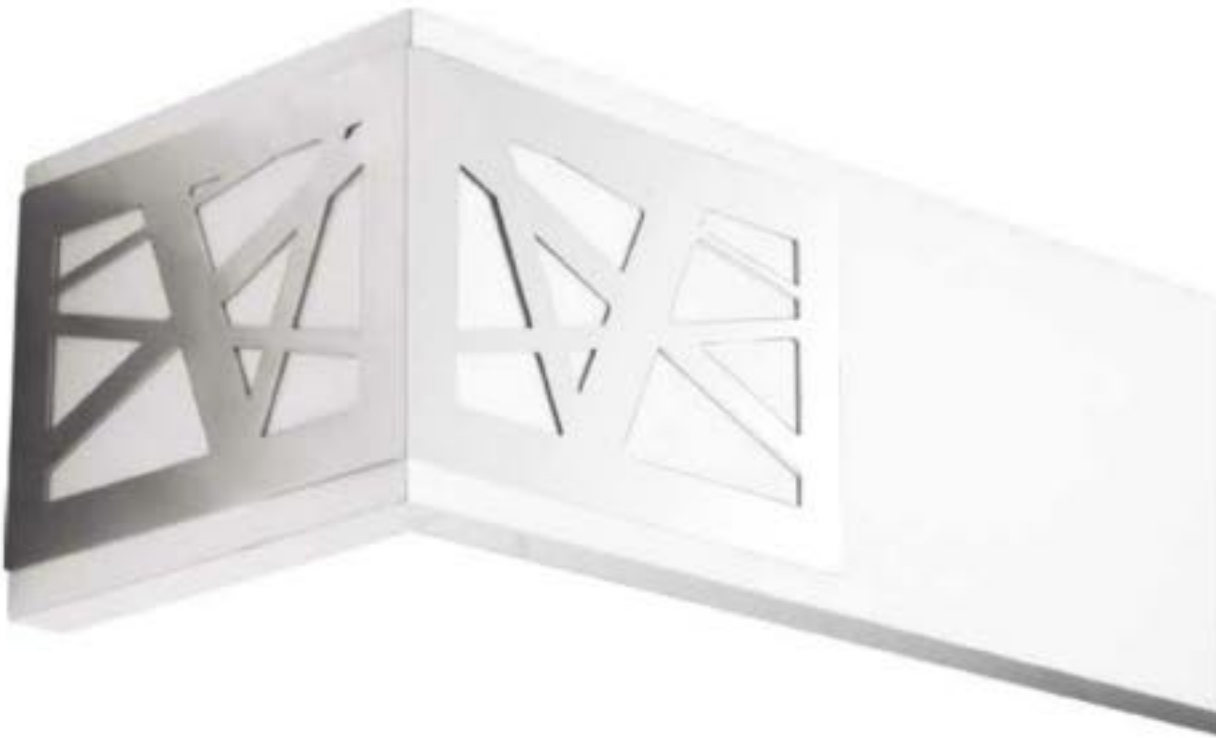

ES 2013
ceviz / walnut
اللون الجوز / opex



ES 2007
beyaz / white
أبيض / beyaz



ES 2012
zebrano / zebrano
زبرانو / Zebrano



ES 2014
kayın / beech
خشب الزان الطبيعي / Prirodni drvo



ES 2020
abonoz / ebony
خشب الأبنوس الطبيعي / prirodno drvo



ES 2021
kök ceviz / kök walnut
خشب الأبنوس الطبيعي / Prirodni drvo



ES 3013
ceviz / walnut
اللون الجوز / opex



ES 3007
beyaz / white
أبيض / beyaz



ES 3012
zebrano / zebrano
زاجرانو / Зебрано



ES 3014
kayın / beech
خشب الزان الطبيعي / Природный бук



ES 3020
abanoz / ebony
خشب الأبنوس الطبيعي / черное дерево



ES 3021
kök ceviz / kök walnut
خشب الأبنوس الطبيعي / Коричневое покрытие



DEKORATİF RAY

DR 01
beyaz / white
بىيىز / أبيض



DR 02
krem / cream
لون كرىم / Цвет крема



DR 04
mat krom / chrome
مات كروم / Матовый хром



DR 04
meşe / beech
اللون البلوط / Цвет дуба



DR 06
ceviz / walnut
اللون الجوز / Цвет ореха



DR 06
siyah / black
أسود / Черный



DEKORATİF TEK KANALLI RAY

30 x 21

DR2 01 beyaz / white / بىيىز / أبيض



DEKORATİF ÜÇ KANALLI RAY

30 x 85

DR3 01 beyaz / white / بىيىز / أبيض



DEKORATİF RAY APARATLARI

DRUA 01
beyaz / white / بىيىز / أبيض



DRUA 02
krem / cream / لون كرىم / Цвет крема



DRUA 03
mat krom / chrome / Матовый хром



DRUA 04
meşe / beech / اللون البلوط / Цвет дуба



DRUA 06
ceviz / walnut / اللون الجوز / Цвет ореха



DRUA 07
siyah / black / أسود / Черный



DRKA 01
beyaz / white



DRKA 02
krem / cream



DR2K 01
beyaz / white



DR2K 02
krem / cream



DRKA 03
mat krom



DRKA 04
meşe



DR2K 03
mat



DR2K 04
meşe



DRKA 06
ceviz



DRKA 07
siyah / black



DR2K 06
ceviz



DR2K 07
siyah / black



HOSPITAL RAIL SYSTEM



Tavan Askı Montaj Aparatı



Askı Çubuğu



Duvar Aparatı





Tavan Bağlantı Aparatı



Rulet



Ray Kapağı



ALÜMİNYUM RAY



Üçlü Alüminyum Ray
Single Aluminium Rail Ceiling
Трёхшпунный алюминитый потолочный карниз
السكك الحديدية لألومنيوم الثلاثي



İkili Alüminyum Ray
Single Aluminium Rail Ceiling
Двухшпунный алюминитый потолочный карниз
السكك الحديدية الألومنيوم ثنائي



Tekli Alüminyum Ray
Single Aluminium Rail Ceiling
Одношпунный алюминитый потолочный карниз
السكك الحديدية الألومنيوم واحد



Portraylı Alüminyum Ray
Single Aluminium Rail Ceiling Bracket
Одношпунный алюминитый потолочный карниз с направляющим
السكك الحديدية الألومنيوم واحد

